

Megadap<sup>®</sup>

# 使用说明书

## User Manual

### M2RF

M to RF 自动转接环

M to RF Autofocus Adapter

迦百列电子科技有限公司出品

Designed & Made by GABALE Electronic Technology Co., Ltd



扫码观看

M2RF操作指南视频

## 产品信息

品 牌	Megadap
型 号	M2RF
支持相机	佳能RF卡口全系列微单相机
兼容镜头	兼容镜头:徕卡M、福伦达VM、蔡司ZM等M卡口手动镜头,或通过其他转接环转换为M卡口的手动镜头
材 质	黄铜+不锈钢+太空铝
重 量	161g

## 注意!

将转接环安装至相机、从相机取下或将镜头安装至转接环时，请先关闭相机电源，避免热插拔操作。

请选择一个没有阳光直射的地方，并注意防止灰尘进入设备。

镜头安装过程中，请勿按下相机或转接环上的镜头释放按钮。

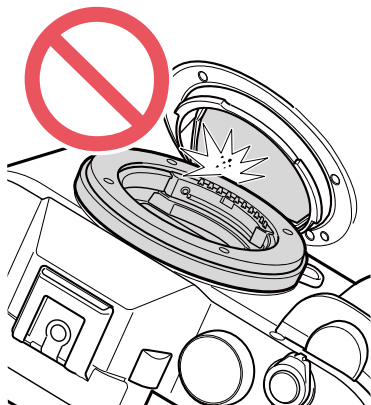
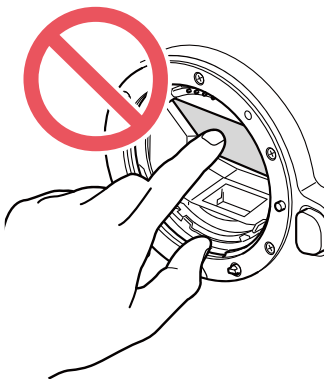

# 目录

注意事项.....	02
产品简介.....	03
安装与拆卸.....	06
主要功能.....	10
使用步骤.....	11
软件使用.....	12
固件升级方法.....	16
使用说明.....	18
故障排除.....	23
技术支持.....	25

## 注意事项

### 安全提示：

- △为降低火灾或触电风险，请勿将本设备置于雨中或潮湿环境中。
- △请将本设备置于儿童无法触及的地方，以免造成儿童意外伤害。
- △禁止自行拆解、改装本设备，否则将丧失保修权益。

### 注意事项与保养：

- 本转接环为高精度设备，请勿摔落或遭受物理撞击。
- 请保持转接环干燥，内部部件生锈会造成不可逆的损坏。
- 请勿在多尘或潮湿的地方安装或更替转接环。
- 请勿用手指直接接触芯片触点，否则会造成触点腐蚀，进而导致芯片工作异常。
- 请勿触摸转接环内部，如有灰尘请使用气吹或软刷清除。
- 请勿使用酒精、苯、稀释剂或其他有机溶剂擦拭此转接环。
- 若长期不使用转接环，请存放于阴凉干燥处，防止发霉、生锈；避免存放于实验室等存在腐蚀性化学品的环境中。

## 产品简介

M2RF转接环是一款专为佳能RF卡口微单相机打造的、可实现M卡口手动镜头自动对焦的转接环，支持多组镜头参数配置与自定义设置。本指南将帮助您掌握转接环的安装、配置与使用方法。



## 产品图示：正面

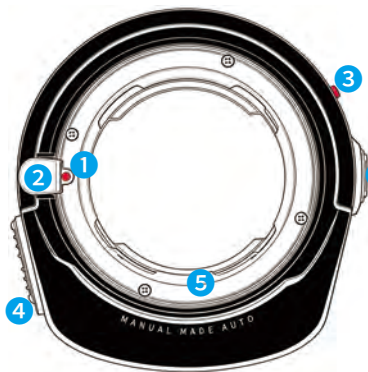

## 产品图示：背面

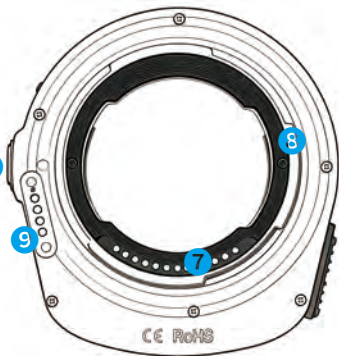

1. 镜头安装指示点

4. 光圈档位拨钮

7. 相机CPU触点

2. 镜头释放按钮

5. M卡口

8. RF卡口

3. 转接环安装指示点

6. AF/MF多功能开关

9. 磁吸固件升级接口

## 产品图示：左侧



2.镜头释放按钮

6.AF/MF多功能开关

3.转接环安装指示点

8.RF卡口

## 产品图示：右侧



4.光圈档位拨钮

## 安装与拆卸

### 1. 将转接环安装至相机。

对齐转接环与相机的安装标记, 将转接环推入相机卡口, 顺时针旋转直至听到“咔嗒”声, 确认卡紧到位。

### 2. 将镜头安装至转接环。

对齐镜头与转接环的安装标记, 将镜头对准转接环卡口推入, 顺时针旋转直至听到“咔嗒”声, 确认卡紧到位。

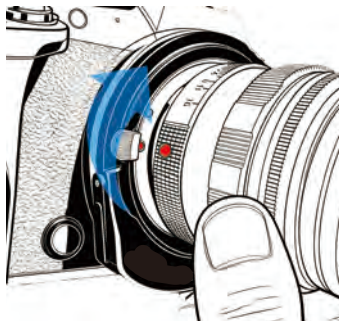

## 取下镜头

1. 按住转接环上的镜头释放按钮，逆时针旋转镜头；
2. 取下镜头后，请盖好镜头前后盖。

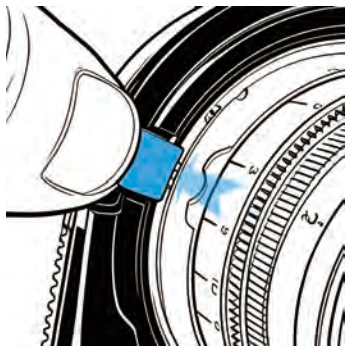

## 取下转接环

1. 按住相机的镜头释放按钮，逆时针旋转转接环；
2. 取下转接环；
3. 盖好转接环前后盖与相机机身盖。

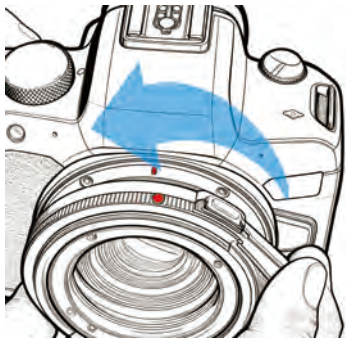
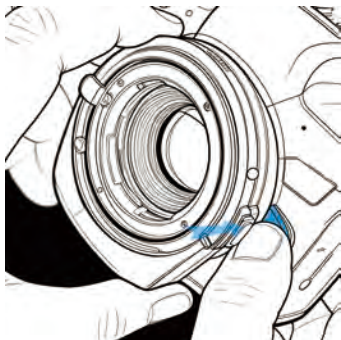

## 转接环核心工作原理

1. 本转接环的自动对焦功能,通过内置电子螺旋传动机构伸缩推动镜头,实现合焦。
2. 本转接环无法直接控制镜头的焦距与光圈,拍摄时需在镜头上手动调节;可通过专用软件向转接环内录入4支镜头的名称、焦段、光圈信息,设置完成后相关参数可同步至相机,并写入拍摄照片的EXIF信息中。

对焦环

光圈环

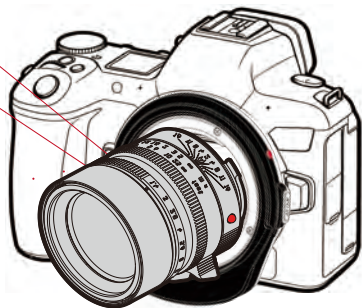

## 主要功能

### 1. 手动镜头自动对焦

可实现徕卡M、福伦达VM、蔡司ZM等M卡口手动镜头，或通过其他转接环转换为M卡口的手动镜头的自动对焦功能。

### 2. 一次设置4组镜头数据(详见12-15页)

可通过软件设置4组镜头参数，记录镜头型号、光圈值、焦距等信息至照片EXIF中。

### 3. 四档光圈值实时切换(详见20-21页)

实现相机端光圈值与镜头实际光圈的手动同步。

### 4. 镜头快速切换功能(详见19页)

可通过操作指令快速切换已预设的4组镜头参数。

### 5. 自动对焦/手动对焦一键切换(详见22页)

### 6. 固件更新支持(详见16页)

## 使用步骤

1. 使用原厂磁吸数据线将M2RF适配器连接至电脑；
2. 使用Megadap M2RF Custom Tool自定义镜头数据；
3. 保存镜头数据至转接环，断开磁吸数据线连接；
4. 将M2RF转接环连接到相机机身；
5. 将镜头安装到转接环上；
6. 确保设备正常连接，开启相机电源；
7. 即可正常拍摄使用。

# 软件使用

## 1. 下载并解压软件

前往官网 <https://www.megadap.com/> 下载“Megadap M2RF Custom tool.zip”，解压缩至电脑中。

## 2. 安装软件

### 2.1 Windows 系统：

系统可能跳出“用户账户控制”的安全提示，请点击“是”，并等待安装完成。

### 2.2 Mac 系统：

安装时可能出现以下警告：“该 App 未经审核，且 macOS 也无法检查它是否在发布后被修改或破坏。”

请按以下步骤操作安装：点击苹果菜单 → “系统设置” → 点选左侧“隐私与安全性”（可能需要向下滚动） → 在“安全性”栏目中点击“打开” → 点击“仍要打开” → 输入登录密码 → 点击“好”。

### 3. 连接转接环至电脑

使用原厂磁吸数据线将M2RF转接环连接至电脑  
(Windows、Mac系统均可)

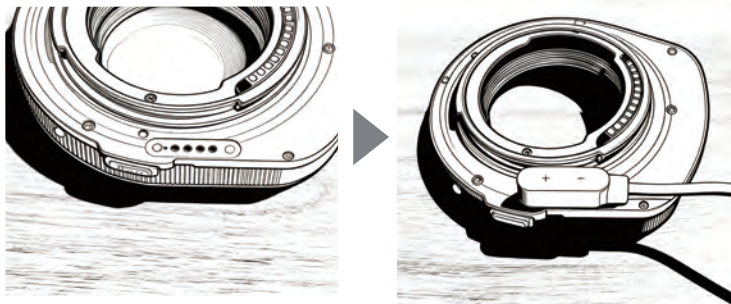

连接后,电脑中会出现名为“M2RF DFU”的磁盘。

### 4. 启动数据写入模式

打开“Megadap M2RF Custom tool”软件,按一下转接环上的AF/MF多功能开关,此时转接环进入数据写入状态。

## 5. 设置镜头资料

5.1 转接环可以记录4支手动镜头的焦段信息、光圈信息、型号信息，分别记录在“A、B、C、D”组中，镜头信息会同步到照片的EXIF信息并最大化增强自动对焦的性能。

\*注:A、B、C、D四组镜头分别对应F2.2、F2.5、F2.8、F3.2光圈代号，该组数值仅用于相机机身切换镜头参数，不代表镜头的实际光圈值；详情参见第19页 切换镜头参数。

5.2 每组可设定4个“光圈”值(用来为快速切换光圈数值以满足不同场景下的拍摄需求，建议依照镜头光圈环，从最大光圈开始依序输入)。

5.3 可自定义“镜头型号”，例如：“LEICA SUMMICRON-M 35MM F2 ASPH”。

5.4 选择“默认镜头”(A/B/C/D 其中一个)，作为开机后初始使用镜头。

(详情参见第19页「切换镜头参数」章节)

## 6. 保存设置并退出

点击“保存到转接环” → 点击“退出程序” → 完成镜头参数设定。



Megadap M2RF custom tool 软件界面参考

# 固件升级方法

## 1. 下载固件

从官网 <https://www.megadap.com/> 下载固件 zip 文件，解压后得到后缀为 .BIN 的固件文件（例如：Megadap M2RF Ver1.0.5.BIN）。

## 2. 连接接环至电脑

用原厂磁吸数据线将 M2RF 转接环连接至电脑，此时电脑中会显示磁盘“M2RF DFU”。

## 3. 拷贝固件文件到磁盘

将 .BIN 文件拖入或复制粘贴到磁盘“M2RF DFU”中，系统将在 5 秒内自动完成固件安装。

## 4. 升级过程注意事项

**4.1.Windows 系统:**安装完成后磁盘会自动重新加载，此时表示升级已成功，可手动弹出磁盘。

- 4.2 **Mac 系统:**安装过程中可能弹出 Finder 错误提示:“访达不能完成该操作...”。可忽略此提示,固件已经成功写入。手动推出磁盘即可。
- 4.3 **版本确认:**可在磁盘内的 README 文档中查看当前固件版本,或通过相机菜单中「镜头固件」选项查看版本号。

# 使用说明

## 1. 安装镜头

安装镜头前请关闭相机电源, 将M卡口镜头 (或通过第三方转接环转为M卡口的镜头) 牢固安装至M2RF转接环。

**使用前请将镜头对焦环旋至无限远位置, 对焦行程过长的镜头, 可根据实际对焦距离调整对焦环初始位置。**

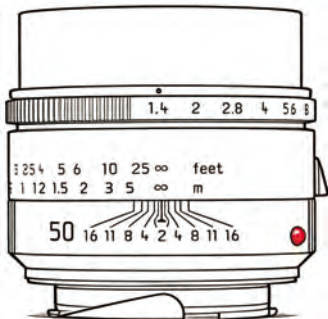
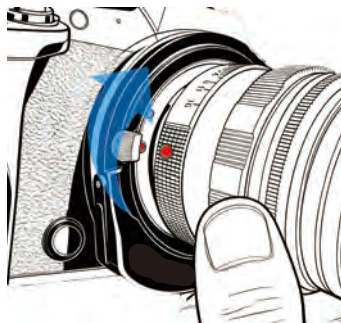

## 2. 切换镜头参数

镜头切换模式操作步骤如下：

2.1 开启相机电源；

2.2 待转接环自检复位完成后，长按 AF/MF 按钮 3 秒，转接环进入镜头切换模式；

2.3 拨动相机机身上的光圈拨轮 $v$ ，选择与 A、B、C、D 四组镜头对应的指示光圈值：

- 屏幕显示 F2.2 → 对应 A 组镜头参数
- 屏幕显示 F2.5 → 对应 B 组镜头参数
- 屏幕显示 F2.8 → 对应 C 组镜头参数
- 屏幕显示 F3.2 → 对应 D 组镜头参数

2.4 释放一次快门，确认所选的镜头组别，随后关闭相机电源；

2.5 重新开启相机电源，长按 AF/MF 按钮 3 秒，此时屏幕显示的光圈数值与所选组别镜头指示光圈值一致，即完成参数切换。

### 3. 切换相机光圈值

3.1 转动镜头光圈环，选择要使用的实际光圈。

3.2 调节转接环上的光圈档位拨钮，选择对应预设档位。

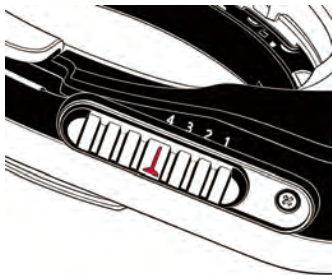
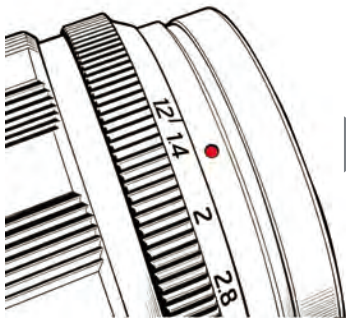

### 3.3 确认相机端显示的光圈值是否与镜头端一致(每组镜头可使用四档预设光圈值)。

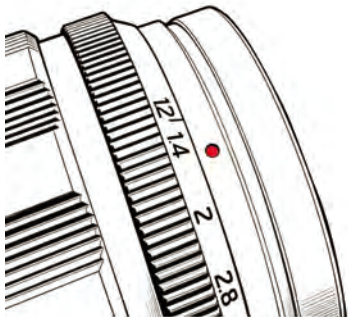
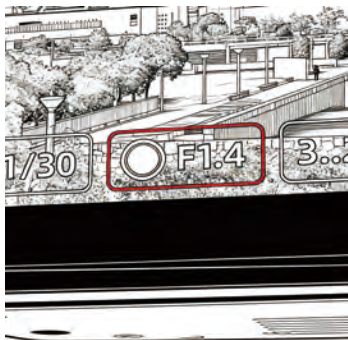

**⚠ 重要提示: 镜头上的实际光圈值必须与相机端设置一致, 否则会影响自动对焦速度与合焦精度。**

## 4. 切换AF/MF模式

4.1 单击AF/MF多功能开关:切换自动对焦(AF)与手动对焦(MF)模式。

注:按下按键切换至MF模式后,转接环会回缩至无限远位置(收缩至最低位置)。

4.2 在MF模式下,双击AF/MF多功能开关,转接环将完全伸出,进入手动微距模式(伸出至最高位置);再次双击AF/MF多功能开关,转接环恢复至无限远模式(收缩至最低位置)。

## 故障排除

若设备出现异常, 请先参考以下对应方案排查解决:

- 若转接环与电脑连接失败, 请检查数据线连接情况;
- 若镜头切换功能失效, 请确认镜头组别对应的光圈代号设置是否正确;
- 若固件升级失败, 请重新下载固件, 重新连接转接环后重试。

故障现象	排查方法
转接环与电脑连接失败	<ol style="list-style-type: none"><li>1. 检查数据线是否为原配且连接牢固</li><li>2. 确认电脑串口设置正常</li><li>3. 重启软件后重新连接</li></ol>
镜头切换功能失效	<ol style="list-style-type: none"><li>1. 确认光圈值设置与镜头数据组别对应一致</li><li>2. 检查相机是否完成快门释放确认步骤</li><li>3. 重启相机后重新操作</li></ol>

固件升级失败	<ol style="list-style-type: none"><li>1. 检查固件文件完整性(未损坏、未修改后缀)</li><li>2. 重新下载固件并重复升级步骤</li></ol>
自动对焦不准确	<ol style="list-style-type: none"><li>1. 核对镜头光圈值与相机端设置是否一致</li><li>2. 检查镜头安装是否牢固</li><li>3. 确认镜头数据参数设置正确</li></ol>

## 技术支持

如需技术支持, 请联系:

**邮箱:** [support@megadap.com](mailto:support@megadap.com)

**网站:** [www.megadap.com](http://www.megadap.com)

### 版权声明:

本指南内容受版权保护, 未经授权不得擅自复制、传播或修改。产品参数及功能可能因固件升级发生变化, 最新操作指南请以官网发布为准。

## Product Information

<b>Brand</b>	Megadap
<b>Model</b>	M2RF
<b>Compatible Cameras</b>	All Canon RF-mount mirrorless cameras
<b>Compatible Lenses</b>	Leica M, Voigtländer VM, Zeiss ZM and other M-mount manual lenses, or other manual lenses converted to M-mount via a third-party adapter
<b>Material</b>	Brass+Stainless Steel+Aerospace Aluminum
<b>Weight</b>	161g

## Operating Precautions

When installing the adapter to the camera, removing it from the camera, or attaching the lens to the adapter, please turn off the camera power first. Please operate in a place free from direct sunlight and prevent dust from entering the device.

Do not press the lens release button on the camera or adapter during lens installation.

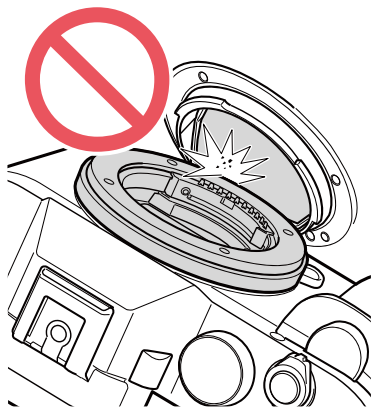
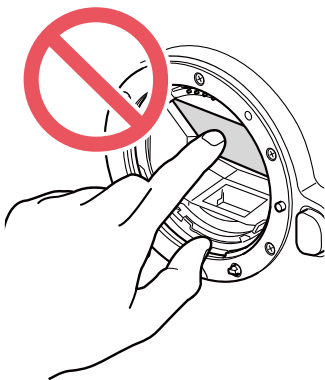

# Contents

Attention.....	29
Introduction.....	31
Installation & Removal.....	34
Key Features.....	38
Operating Steps.....	39
Software Usage.....	40
Firmware Update.....	44
Instructions.....	46
Troubleshooting.....	51
Technical Support.....	53

## Attention

### Safety Instructions

- ⚠ To reduce the risk of fire or electric shock, do not expose the device to rain or moisture.
- ⚠ Keep this device out of reach of children to avoid accidental injury.
- ⚠ Do not disassemble or modify the device without authorization, as this will void the warranty.

This adapter is a high-precision device; do not drop it or subject it to strong physical impact.

## Operation and Maintenance

- Keep the adapter dry. Rusting of internal components will cause irreversible damage.
- Do not install or remove the adapter in dusty or humid environments.
- Do not touch the chip contacts directly with your fingers—contact corrosion may occur and cause the chip to malfunction.
- Do not touch the interior of the adapter. If dust accumulates, use an air blower or a soft brush to remove it.
- Do not clean the adapter with alcohol, benzene, thinners, or other organic solvents.
- If the adapter is not in use for an extended period, store it in a cool, dry place to prevent mold and rust. Avoid storage in areas with corrosive chemicals (e.g., laboratories).

## Introduction

The M2RF adapter is a dedicated accessory designed for Canon RF-mount mirrorless cameras, enabling autofocus for M-mount manual lenses. It supports multiple lens parameter configurations and custom settings.

This guide will help you master the installation, configuration, and operation of the adapter.



Scan the code to watch  
M2RF Operation Tutorial Video

## Front

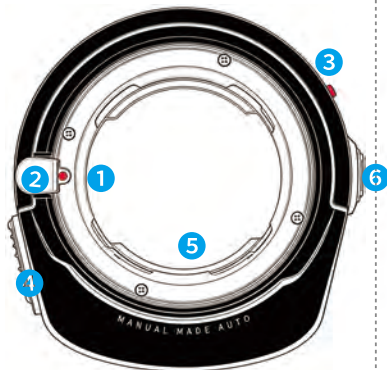

## Back

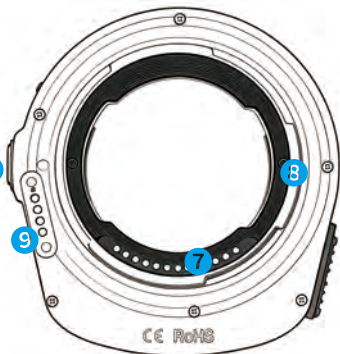

1. Lens Mounting Index
2. Lens Release Button
3. Adapter Mounting Index
4. Aperture Dial
5. M Mount
6. AF/MF Multi-Function Switch
7. Camera CPU Contacts
8. RF Mount
9. Magnetic Firmware Update Port

## Left Side



## Right Side



- 2. Lens Release Button
- 3. Adapter Installation Indicator
- 4. Aperture Dial
- 6. AF/MF Multi-Function Switch
- 8. RF Mount

# Installation&Removal

## 1. Mount the lens mount adapter onto the camera.

Align the mounting marks on the lens mount adapter with those on the camera, press the adapter firmly into the camera's lens mount, and then rotate it clockwise until it clicks into the correct position.

## 2. Mount the lens onto the lens mount adapter.

Align the lens mounting marks with those on the lens mount adapter, place the lens onto the adapter, and then rotate it clockwise until it clicks securely into place.

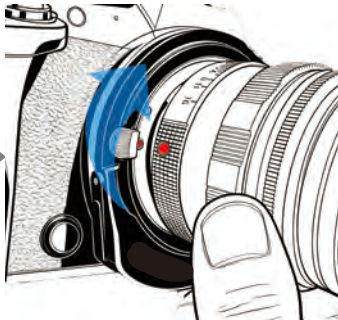

## Removing Lens

1. Press and hold the lens release button on the mount adapter, and rotate the lens counterclockwise.
2. After removing the lens, cover both the front and rear lens caps properly.

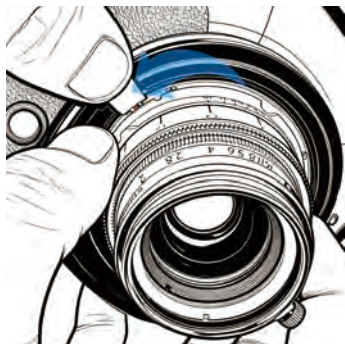
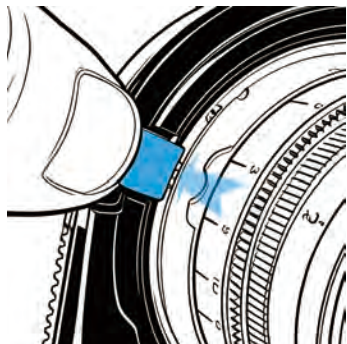

## Removing the Adapter

1. Press and hold the lens release button on the camera, then rotate the mount adapter counterclockwise.
2. Remove the mount adapter.
3. Cover the front and rear caps of the mount adapter properly, as well as the camera body cap.

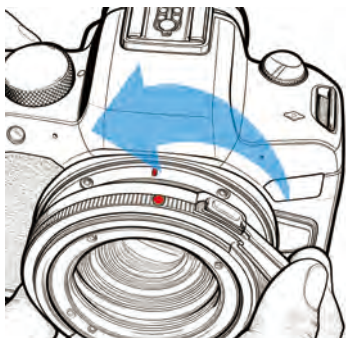
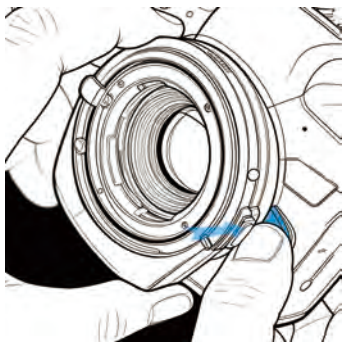

## Using the Mount Adapter

- The autofocus function of this adapter is realized by driving the lens to extend and retract via the built-in electronic screw drive system.
- This adapter cannot directly control the focal length and aperture of the lens, which must be adjusted manually on the lens during shooting.
- You can input the name, focal length and aperture information of up to 4 lenses into the adapter via the dedicated software, and the settings will be synchronized to the camera after completion.

Focus Ring

Aperture Ring

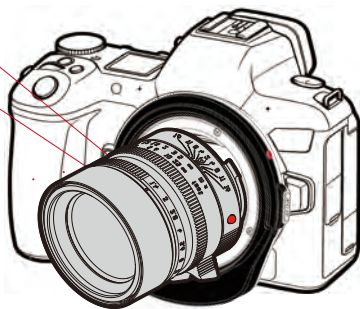

## Key Features

### **1. Manual Lens Autofocus**

Enables autofocus for M-mount manual lenses, or other manual lenses converted to M mount via an adapter

### **2. 4 Sets of Lens Data Storage (Page 40-43)**

Allows you to set different lens parameters via software, and record lens model, aperture, focal length and other information to the photo EXIF

### **3. 4 Aperture Values Real-time Switching (Page 48-49)**

Realizes manual synchronization between the camera aperture value and the actual lens aperture

### **4. Lens Switching Function (Page 47)**

Quickly switch between 4 preset lens groups via operation of commands

### **5. One-click autofocus/manual focus switching (Page 50)**

### **6. Firmware Update Support (Page 44)**

## Operating Steps

1. Connect the M2RF adapter to the computer using the original magnetic data cable;
2. Customize the lens data with the Megadap M2RF Custom Tool;
3. Save the lens data to the adapter, then disconnect the magnetic data cable;
4. Mount the M2RF adapter to the camera body;
5. Attach the lens to the adapter;
6. Confirm the connection is normal, then turn on the camera;
7. Start shooting.

# Software Usage

## 1. Software Download and Extraction

Visit the official website at <https://www.megadap.net/> to download the "Megadap M2RF Custom tool.zip" compressed package, and extract it to a designated folder on your computer. The extracted files include the application program, multi-language help documents, and configuration files .

## 2. Software Installation

### 2.1 Windows System

Run "Megadap\_M2RF adapter.exe" from the extracted folder. If the system displays a "User Account Control" security prompt, click "Yes" and wait for the installation to complete automatically.

### 2.2 Mac System

If a security warning "Apple cannot verify 'M2RF'" appears during installation, follow these steps:

2.2.1 Click the Apple menu → select "System Settings"

2.2.2 Scroll down in the left menu and select "Privacy & Security"

2.2.3 Click "Open" in the "Security" section and choose "Open Anyway".

2.2.4 Enter your computer login password and click "OK" to complete the installation.

### 3. Connecting the Adapter to the Computer

Use the original data cable to connect the M2RF Adapter to the computer (compatible with both Windows and Mac systems) via magnetic suction. Once connected successfully, the computer will recognize a disk named "M2RF DFU" .

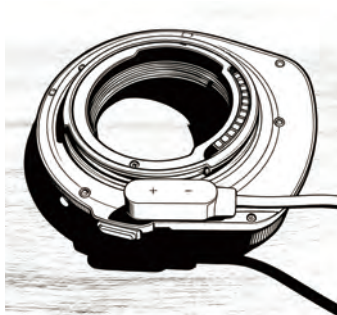
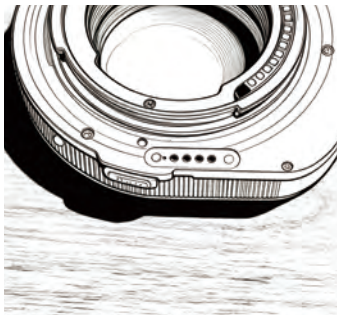

#### 4. Activating Data Writing Mode

Open the installed "Megadap M2RF Custom tool" software and press the AF/MF button on the adapter. The adapter will then enter data writing mode, and the software will then display "Connected" .  
(successfully connected to the serial port)

#### 5. Lens Data Settings

The adapter can store parameters for 4 manual lenses (corresponding to Groups A, B, C, and D respectively). After setup, the lens information will be synchronized to the photo's EXIF data and optimize autofocus performance. Follow these steps:

- 5.1 **Focal Length Setting:** Enter the actual focal length (mm) of the corresponding lens.
- 5.2 **Aperture Setting:** Each group can preset 4 aperture values. It is recommended to enter them in order from the lens's maximum aperture to minimum aperture in order to adapt to different shooting scenarios.
- 5.3 **Custom Lens Model:** Enter the specific lens model (e.g., "LEICA SUMMICRON-M 35MM F2 ASPH").
- 5.4 **Default Lens Selection:** Choose one group from A, B, C, or D as the default lens on startup.

⚠ Note: The markings A(F2.2), B(F2.5), C(F2.8), and D(F3.2) after each group are not actual aperture values, but only for group identification during lens data switching.  
(Please refer to the instructions on page47 for details.)

## 6. Saving Settings and Exiting

- 6.1 After completing parameter settings, click "Save to Adapter" on the software interface;
- 6.2. Once the save is confirmed successful, click "Exit " to finish the lens data configuration.

English Help Save to Adapter Exit

Device Model Megadap M2RF

Device S/N A1MR25B23SN00001

Firmware Version 1.1.0

Default Lens Lens A

检测到 1 个M2RF 设备 (共5 个串口)  
正在自动连接...  
自动连接成功  
DataStructureManager: 成功连接到串口: /dev/cu.usbmodemM2RF338B3630  
SaveToAdapter按钮已启用

Lens	Focal Length(mm)	Aperture	Aperture	Aperture	Aperture	Lens Model
A	21	F1.4	F4.0	F6.3	F8.0	Voigtlander Nokton 21mm f/1.4 Aspherica
B	35	F2.0	F4.0	F5.6	F8.0	ZEISS Biogon T 35mm f/2 ZM*
C	50	F1.4	F2.8	F5.6	F11	Leica Summilux-M 50mm f/1.4 E43
D	75	F1.2	F1.4	F5.6	F8.0	Leica Noctilux-M 75mm f/1.25 ASPH.

# Firmware Update

## 1. Firmware Download

Download the firmware compressed package from the official website at <https://www.megadap.net/>. After extraction, you will obtain a firmware file with the .BIN extension (e.g., "Megadap M2RF Ver1.0.5.BIN").

## 2. Connecting the Adapter to the Computer

Use the original data cable to connect the M2RF Adapter to the computer. The computer will recognize a disk named "M2RF DFU"

## 3. Firmware Installation

Drag or copy the extracted .BIN firmware file into the "M2RF DFU" disk. The system will automatically complete the firmware writing within 5 seconds.

## 4. Update Notes

- 4.1 Windows System:** After installation, the disk will reload automatically, indicating a successful update. You can eject the disk manually;

- 4.2 Mac System:** If a Finder error prompt "The operation can't be completed" appears during installation, it can be ignored directly (the firmware has been successfully written).  
Manually eject the disk .
- 4.3 Version Confirmation:** You can check the current firmware version via the README.txt document in the disk or the "Lens Firmware" option in the camera menu.

# Instructions

## 1. Supplementary Notes on Lens Installation

When installing an M-mount lens, ensure the lens is fully seated on the adapter interface without looseness.

2. It is recommended to turn the focus ring to infinity before use.
3. For lenses with an excessively long focus throw, adjust the focus ring according to the focusing distance.

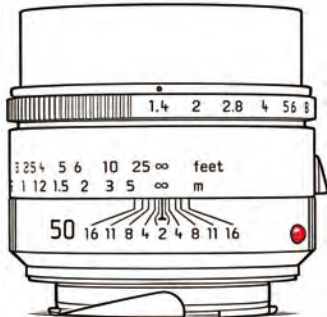
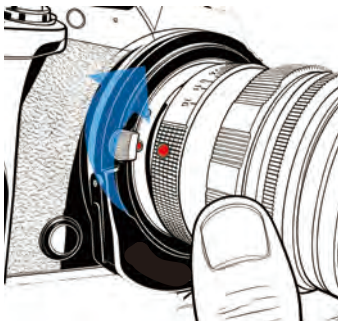

## 2. Switching Lens Data

To switch between the preset lens data in Groups A, B, C, and D, follow these steps:

- 2.1 Turn on the camera power
- 2.2 After the self-inspection and reset are completed, press and hold the "AF/MF Multi-Function Switch" for 3 seconds to enter the lens switching mode;
- 2.3 Rotate the aperture dial on the camera body to select the indicator aperture value corresponding to each lens group:  
Display F2.2 on the screen → Corresponding to Group A lens data;  
Display F2.5 on the screen → Corresponding to Group B lens data;  
Display F2.8 on the screen → Corresponding to Group C lens data;  
Display F3.2 on the screen → Corresponding to Group D lens data;
- 2.4 Release the shutter once to confirm the selected group, then turn off the camera;
- 2.5 Restart the camera. The aperture value displayed on the screen will correspond to the preset value in the adapter's aperture gear Dial, indicating successful data switching.

### 3. Switching Camera Aperture Value

- 3.1 Manually set the target aperture value on the lens;
- 3.2 Adjust the "aperture Dial" on the adapter to select the preset aperture level;

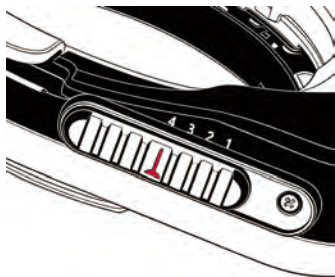
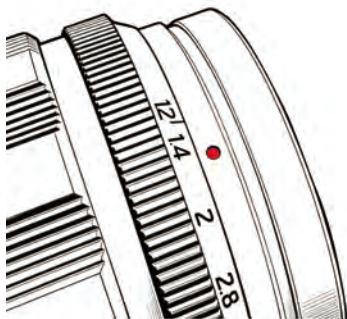

3.3. Confirm that the aperture value displayed on the camera matches the one set on the lens

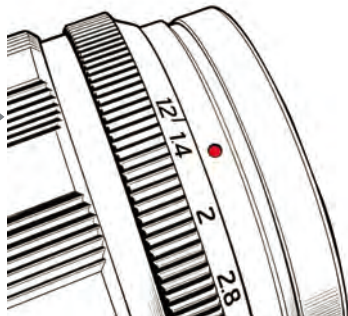
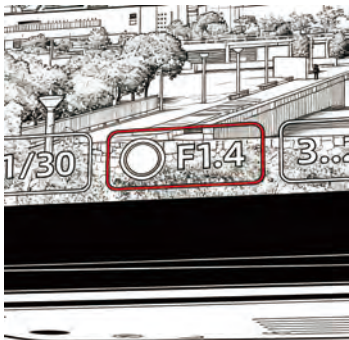

⚠ Important Note: The aperture value on the lens must match the setting on the camera; otherwise, it will result in slower autofocus speed and reduced focusing accuracy.

## 4. Switching AF/MF Modes

4.1. Press the "AF/MF Multi-Function Switch" once: Switch between Auto Focus (AF) and Manual Focus (MF) modes;

⚠ Note: After switching to MF mode by pressing the button, the adapter will retract to the infinity position (the adapter contracts to the lowest position).

4.2 In MF mode, double-click the "AF/MF Multi-Function Switch", and the adapter will fully extend to enter the manual macro mode (extended to the maximum position). Double-click the "AF/MF Multi-Function Switch" again, and the adapter will revert to the infinity mode (retracted to the minimum infinity position).

# Troubleshooting

- 1.If the Adapter failed to connect to the computer., please check the original magnetic data cable connection.
- 2.If lens switching malfunctions, please confirm whether the aperture value representing the lens model is set correctly.
- 3.If the firmware update fails, please re-download the firmware, reconnect the adapter ring and try again.

Fault Phenomenon	Troubleshooting Methods
Adapter failed to connect to the computer.	<ol style="list-style-type: none"><li>1. Check that the data cable is original and securely connected.</li><li>2. Ensure the computer serial port settings are correct.</li><li>3. Restart the software and reconnect.</li></ol>

<p>Invalid lens switching function</p>	<ol style="list-style-type: none"><li>1. Ensure the aperture value setting matches the corresponding lens data group.</li><li>2. Check that the camera has completed the shutter release confirmation step.</li><li>3. Restart the camera and try again.</li></ol>
<p>Firmware update failed</p>	<ol style="list-style-type: none"><li>1. Check the integrity of the firmware file (undamaged and unmodified file extension);</li><li>2. Re-download the firmware and repeat the update steps</li></ol>
<p>Autofocus inaccurate</p>	<ol style="list-style-type: none"><li>1. Verify that the lens aperture value matches the camera setting;</li><li>2. Check if the lens is securely installed;</li><li>3. Confirm that the lens data parameters are set correctly</li></ol>

## Technical Support

If you encounter any issues during product use or need further assistance, please contact us through the following channels:

**Official Website:** [www.megadap.net](http://www.megadap.net)

**Customer Service Email:** [support@megadap.net](mailto:support@megadap.net)

## Copyright Notice

The content of this guide is protected by copyright. No reproduction, distribution, or modification is permitted without authorization. Product parameters and functions may change due to firmware updates. For the latest operation guide, please refer to the official website.



- 在使用本产品之前,请务必先仔细阅读此使用说明书
- 请务必妥善保管好此说明书,以便日后能随时查阅(保留备用)
- 请在充分理解内容的基础上,正确使用
- Before using this product, please read this user manual carefully.
- Please keep this manual properly for future reference.
- Please use this product correctly after fully understanding the contents.

## 迦百列电子科技有限公司

GABALE Electronic Technology Co., Ltd

---

经营/Manages: 专业相机配件及专用镜头转接环

Camera equipment and special lens adapter ring

邮箱/E-mail: support@megadap.com (中文)

support@megadap.net (EN)

网站/Web: www.megadap.com (中文)

www.megadap.net (EN)

**Made in China**